

Register your instrument!  
[www.eppendorf.com/myeppendorf](http://www.eppendorf.com/myeppendorf)



# Centrifuge 5424/5424 R

Operating manual

Copyright © 2013 Eppendorf AG, Hamburg. No part of this publication may be reproduced without the prior permission of the copyright owner.

### **Trademarks**

Eppendorf® and the Eppendorf Logo are registered trademarks of Eppendorf AG.

Microtainer® is a registered trademark of Becton Dickinson, Franklin Lakes, NJ, USA.

Trademarks are not marked in all cases with ™ or ® in this manual.

## Table of contents

<b>1</b>	<b>Operating instructions</b>	<b>5</b>
1.1	Using this manual	5
1.2	Danger symbols and danger levels	5
1.2.1	Hazard symbols	5
1.2.2	Danger levels	5
1.3	Abbreviations used	6
<b>2</b>	<b>Product description</b>	<b>7</b>
2.1	Main illustration	7
2.2	Delivery package	8
2.2.1	Centrifuge 5424	8
2.2.2	Centrifuge 5424 R	9
2.3	Features	9
2.4	Rotors	10
2.4.1	Rcf display and calculation	11
<b>3</b>	<b>Safety</b>	<b>13</b>
3.1	Intended use	13
3.2	User profile	13
3.3	Application limits	13
3.3.1	Declaration concerning the ATEX directive (94/9/EC)	13
3.3.2	Maximum service life for accessories	13
3.4	Information on product liability	14
3.5	Warnings for intended use	15
3.5.1	Personal injury or damage to the equipment	15
3.5.2	Incorrect handling of the centrifuge	16
3.5.3	Incorrect handling of the rotors	16
3.5.4	Extreme strain on the centrifuging tubes	17
3.5.5	Aerosol-tight centrifugation	18
3.6	Safety instructions located on the device	19
<b>4</b>	<b>Installation</b>	<b>21</b>
4.1	Selecting the location	21
4.2	Preparing installation	21
4.3	Installing the instrument	22
<b>5</b>	<b>Operation</b>	<b>23</b>
5.1	Overview of operating controls	23
5.2	Device menu	25
5.3	Menu navigation	26
5.4	Preparing for centrifugation	26
5.4.1	Switching on the centrifuge	26
5.4.2	Inserting the rotor	27
5.4.3	Loading the rotor	27
5.4.4	Closing the centrifuge lid	28

**Table of contents**

Centrifuge 5424/5424 R  
English (EN)

5.5	Cooling (only 5424 R) . . . . .	28
5.5.1	Temperature adjustment . . . . .	28
5.5.2	Temperature display . . . . .	29
5.5.3	Temperature monitoring . . . . .	29
5.5.4	FastTemp . . . . .	29
5.5.5	Continuous cooling . . . . .	29
5.6	Centrifuging . . . . .	30
5.6.1	Centrifugation with time setting . . . . .	31
5.6.2	Centrifuging in continuous operation . . . . .	31
5.6.3	Short-spin centrifugation . . . . .	32
5.6.4	Removing the rotor . . . . .	32
<b>6</b>	<b>Maintenance . . . . .</b>	<b>33</b>
6.1	Prepare cleaning/disinfection . . . . .	33
6.2	Cleaning/disinfection . . . . .	33
6.2.1	Cleaning and disinfecting the device . . . . .	34
6.2.2	Cleaning and disinfecting the rotor . . . . .	35
6.3	Additional service instructions for Centrifuge 5424 R . . . . .	35
6.4	Glass breakage . . . . .	35
6.5	Fuses . . . . .	36
6.6	Decontamination before shipment . . . . .	36
<b>7</b>	<b>Troubleshooting . . . . .</b>	<b>37</b>
7.1	General errors . . . . .	37
7.2	Error messages . . . . .	38
7.3	Emergency release . . . . .	39
<b>8</b>	<b>Transport, storage and disposal . . . . .</b>	<b>41</b>
8.1	Transport . . . . .	41
8.2	Storage . . . . .	41
8.3	Disposal . . . . .	42
<b>9</b>	<b>Technical data . . . . .</b>	<b>43</b>
9.1	Power supply . . . . .	43
9.2	Ambient conditions . . . . .	43
9.3	Weight/dimensions . . . . .	44
9.4	Application parameters . . . . .	44
9.4.1	Centrifuge 5424 . . . . .	44
9.4.2	Centrifuge 5424 R . . . . .	45
<b>10</b>	<b>Ordering Information . . . . .</b>	<b>47</b>
10.1	Centrifuge 5424 . . . . .	47
10.2	Centrifuge 5424 R . . . . .	47
10.3	Accessories . . . . .	48
10.3.1	Rotors and rotor lids . . . . .	48
10.3.2	Adapter . . . . .	48
10.3.3	Other accessories . . . . .	49
10.4	Fuses . . . . .	49

# 1 Operating instructions

## 1.1 Using this manual







- ▶ Read this operating manual completely before using the device for the first time. Please also note the operating instructions for the accessories, if applicable.
- ▶ This operating manual is part of the product. Thus, it must always be easily accessible.
- ▶ Enclose this operating manual when transferring the device to third parties.
- ▶ If this manual is lost, please request another one. You will find the current version on our webpage [www.eppendorf.com/worldwide](http://www.eppendorf.com/worldwide).

The Centrifuge 5424 / 5424 R is available in two versions: **key pad** or **rotary knobs**. This operating manual generally describes how to operate the keypad version but it also applies to the rotary knob version.

## 1.2 Danger symbols and danger levels

The safety notes in these instructions use the following hazard symbols and danger levels:

### 1.2.1 Hazard symbols

	<b>Biohazard</b>		<b>Explosion</b>
	<b>Electric shock</b>		<b>Crushing</b>
	<b>Hazard point</b>		<b>Material damage</b>

### 1.2.2 Danger levels

<b>DANGER</b>	<i>Will lead to serious injuries or death.</i>
<b>WARNING</b>	<i>May lead to serious injuries or death.</i>
<b>CAUTION</b>	<i>May lead to minor or moderate injuries.</i>
<b>NOTICE</b>	<i>May lead to material damage.</i>

### 1.3 Abbreviations used

**PCR**

Polymerase chain reaction

**PTFE**

Polytetrafluorethylene

**RZB/rcf**

Relative centrifugal force – *g*-force in  $\text{m/s}^2$

**rpm**

Revolutions per minute – in rpm

**UV**

Ultraviolet radiation

## 2 Product description

### 2.1 Main illustration

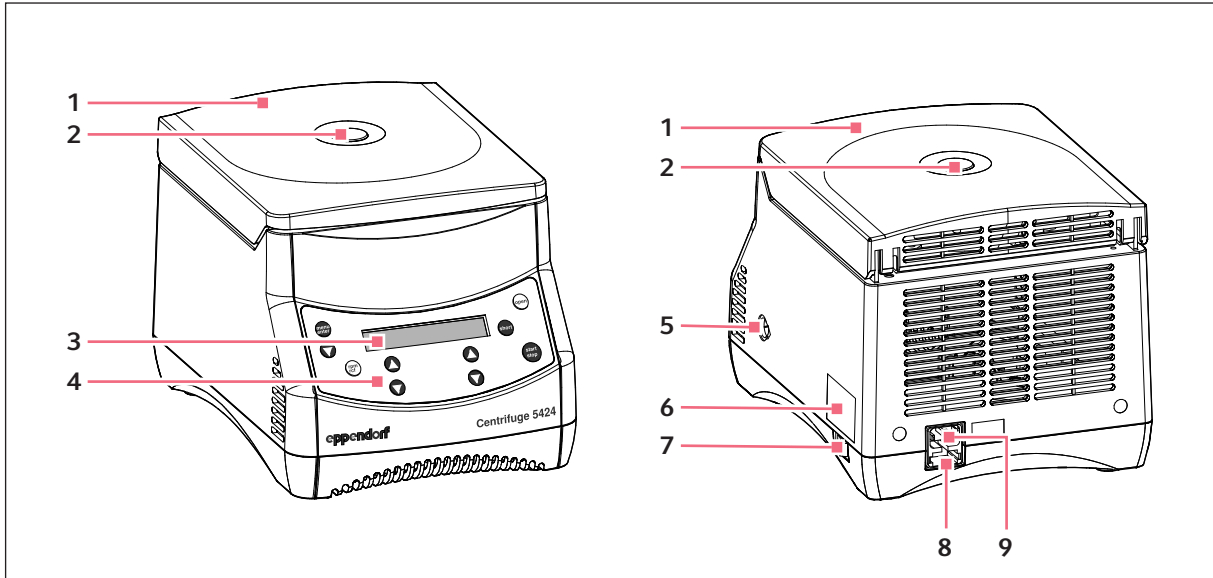

Fig. 2-1: Front and rear view of the Centrifuge 5424

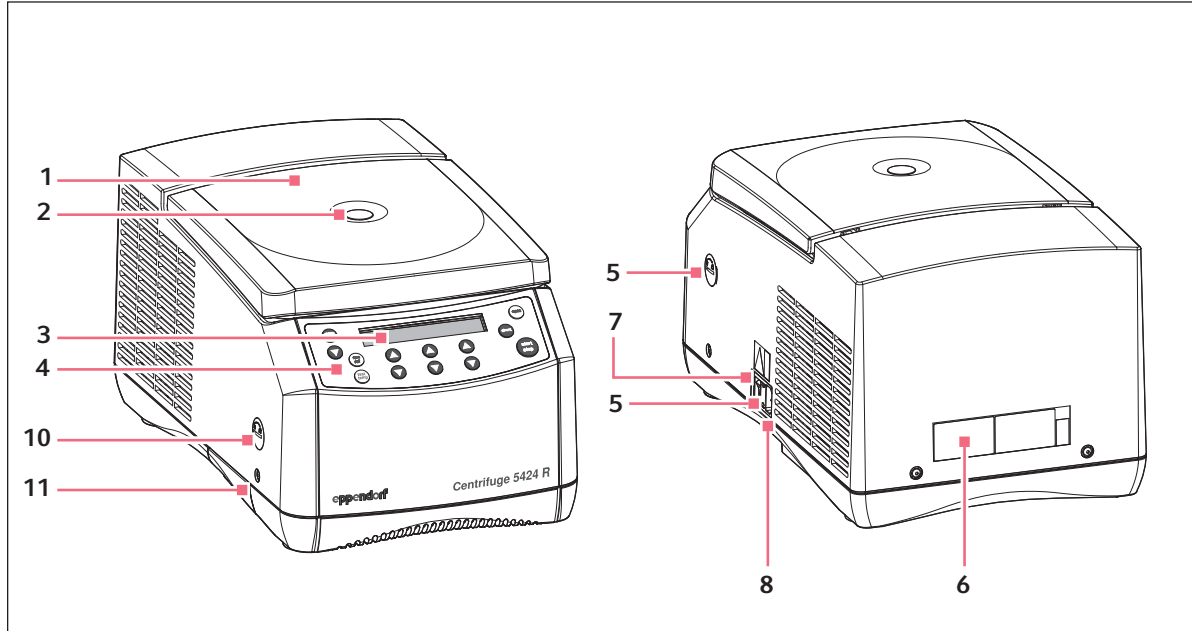

Fig. 2-2: Front and rear view of the Centrifuge 5424 R

**Product description**

Centrifuge 5424/5424 R  
English (EN)

- |  |   |
|--|---|
| <p><b>1 Centrifuge lid</b></p> <p><b>2 Monitoring glass</b><br/>Visual control for rotor stop or speed control option using stroboscope</p> <p><b>3 Display</b><br/>Depiction of the current centrifugation parameters and device settings.(see Fig. 5-2 on p. 24)</p> <p><b>4 Control panel</b><br/>Keys and dials (dependent on the device version) for operating the centrifuge (see Fig. 5-1 on p. 23).</p> <p><b>5 Emergency release</b><br/>(see <i>Emergency release</i> on p. 39)</p> <p><b>6 Name plate</b></p> | <p><b>7 Mains/power switch</b><br/>Switch for switching the device on and off.<br/>Switch position 0: The device is switched off.<br/>Switch position I: The device is switched on.</p> <p><b>8 Mains connection</b><br/>Connection socket for the mains cable supplied.</p> <p><b>9 Fuse holder</b></p> <p><b>10 USB port (only 5424 R)</b><br/>Interface for error analysis and software updates by the Technical Service.</p> <p><b>11 Condensation water tray (only 5424 R)</b></p> |
|--|---|

## 2.2 Delivery package

### 2.2.1 Centrifuge 5424

Quantity	Order no. (International)	Order no. (North America)	Description
1	-	-	<b>Centrifuge 5424</b> See chapter <i>Ordering Information</i> for corresponding device version, equipment and order number
1 or	5424 852.122 5424 852.130	950004267 950004241	<b>Fuse</b> 3,15 A T (230 V), set of 2 6,3 A T (120 V/100 V), set of 2
1	5416 301.001	022634305	<b>Rotor key</b> Standard
1	-	-	<b>Power supply device</b>
1	5404 900.023	5404900023	<b>Operating manual Centrifuge 5424/5424 R</b> Languages: EN, DE, FR, ES, IT, PT
1	5404 900.031	5404900031	Languages: DA, FI, EL, NL, SV (230 V devices only)



## 2.2.2 Centrifuge 5424 R

Quantity	Order no. (International)	Order no. (North America)	Description
1	-	-	<b>Centrifuge 5424 R</b> See chapter <i>Ordering Information</i> for corresponding device version, equipment and order number
1 or	5424 852.122 5424 852.130	950004267 950004241	<b>Fuse</b> 3,15 A T (230 V), set of 2 6,3 A T (120 V/100 V), set of 2
1	5416 301.001	022634305	<b>Rotor key</b> Standard
1	-	-	<b>Power supply device</b>
1	5404 850.085	5404850085	<b>Tray for condensation water</b>
1	5404 900.023	5404900023	<b>Operating manual Centrifuge 5424/5424 R</b> Languages: EN, DE, FR, ES, IT, PT
1	5404 900.031	5404900031	Operating manual Centrifuge 5424/5424 R Languages: DA, FI, EL, NL, SV (230 V devices only)

## 2.3 Features

The versatile Centrifuge 5424 / 5424 R has a capacity of 24 x 2 mL and reaches a maximum of 21,130 x g / 15,000 rpm (5424: 120 V, 5424 R: 230 V, 120 V, 100 V) or 20,238 x g / 14,680 rpm (5424: 230 V, 100 V). You can select between four different rotors to centrifuge the following tubes for your various applications:

- Micro test tubes (0.2 to 2.0 mL)
- PCR strips
- Microtainers (0.6 mL)
- Spin columns (1.5/2.0 mL)

The Centrifuge 5424 R has an additional temperature control function for centrifugation between -10°C and +40°C. The **fast temp** function can be used to start a temperature control run without samples to adjust the rotor chamber quickly to the set target temperature.

**Product description**

Centrifuge 5424/5424 R  
English (EN)

## 2.4 Rotors

You can operate the Centrifuge 5424 / 5424 R with the following rotors. Before use of sample tubes, please note the manufacturer's specifications with regard to centrifugation resistance (max. rcf).

	Max. capacity	Max. g-force (rcf) / speed (rpm) without adapter (5424: 120 V, 5424 R)	Max. g-force (rcf) or speed (rpm) without adapter (5424: 230 V/100 V)	Notes
		Max. load per rotor bore <sup>(1)</sup>		
<b>Rotor FA-45-24-11</b>	24 micro test tubes of 1.5/2.0 mL each or spin columns. With adapters: <ul style="list-style-type: none"> <li>• 0.2 mL PCR tubes</li> <li>• 0.4 mL/0.5 mL micro test tubes</li> <li>• 0.6 mL Microtainers</li> </ul>	21,130 x g / 15,000 rpm	20,238 x g / 14,860 rpm	<ul style="list-style-type: none"> <li>• Aerosol-tight<sup>(2)</sup> rotor lid (aluminum).</li> <li>• Spin columns possible, better with rotor F-45-18-11-Kit.</li> </ul>
<b>Rotor FA-45-24-11-Special</b>	24 micro test tubes of 1.5/2.0 mL each or spin columns. With adapters: <ul style="list-style-type: none"> <li>• 0.2 mL PCR tubes</li> <li>• 0.4 mL/0.5 mL micro test tubes</li> <li>• 0.6 mL Microtainers</li> </ul>	21,130 x g / 15,000 rpm	20,238 x g / 14,860 rpm	<ul style="list-style-type: none"> <li>• Aerosol-tight<sup>(2)</sup> rotor lid (aluminum).</li> <li>• PTFE-coated (particularly resistant to chemicals), marked: <i>coated</i></li> <li>• Spin columns possible, better with rotor F-45-18-11-Kit.</li> </ul>
<b>Rotor F-45-18-11-Kit</b>	18 spin columns or 1.5/2.0 mL micro test tubes. With adapters: <ul style="list-style-type: none"> <li>• 0.2 mL PCR tubes</li> <li>• 0.4 mL/0.5 mL micro test tubes</li> <li>• 0.6 mL Microtainers</li> </ul>	18,111 x g / 15,000 rpm	17,347 x g / 14,860 rpm	<ul style="list-style-type: none"> <li>• Particularly high edge for all commercially available spin columns. See the note about centrifugation with open tube lids in this regard (see <i>Loading the rotor on p. 27</i>).</li> </ul>
<b>Rotor F-45-32-5-PCR</b>	Four PCR strips of 5/8 or 32 PCR tubes of 0.2 mL each.	18,615 x g / 15,000 rpm	17,829 x g / 14,860 rpm	

(1) Maximum load per rotor bore for adapter + tube + content.

(2) Aerosol tightness tested and certified by the Centre for Emergency Preparedness and Response, Health Protection Agency, Porton Down (UK) (see certificates at the end of this operating manual).

For the rotors and rotor lids labeled *coated*, color fluctuations may occur as a result of the production process. These fluctuations have no effect on service life or resistance to chemicals.

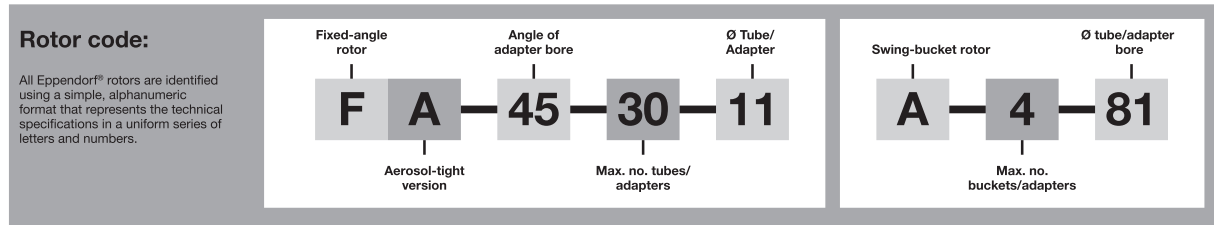

## 2.4.1 Rcf display and calculation



Use the **rpm/rcf** key to switch the display of centrifugation speed between **speed** (rpm) and **g-force** (rcf). Ensure that the g-force displayed upon switching is standardized to suit the rotor FA-45-24-11 without an adapter. When other rotors and adapters are used, you can achieve the following maximum g-forces (rcf) at the maximum speed (see p. 10):

Rotor	Adapters	Max. centrifugation radius $r_{\max}$ [cm]	Max. g-force (rcf) (5424 120 V, 5424 R)	Max. g-force (rcf) (5424 230 V/100 V)
FA-45-24-11, FA-45-24-11-Special	without adapter	8.4	21,130	20,238
	0.2 mL	6.3	15,848	15,179
	0.4 mL	8.4	21,130	20,238
	0.5 mL	7.3	18,363	17,558
	0.6 mL	8.4	21,130	20,238
F-45-18-11-Kit	without adapter	7.2	18,111	17,347
	0.2 mL	5.1	12,829	12,288
	0.4 mL	7.2	18,111	17,347
	0.5 mL	6.1	15,345	14,697
	0.6 mL	7.2	18,111	17,347
FA-45-32-5-PCR	without adapter	7.4	18,615	17,829

To determine the g-force (rcf) for a specific adapter, you can calculate per DIN 58 970 using the following formula:

$$\text{rcf} = 1.118 \cdot 10^{-5} \cdot n^2 \cdot r_{\max}$$

n: revolutions per minute (rpm)

$r_{\max}$ : max. centrifuging radius in cm

### Example

In rotor FA-45-24-11, the 0.5 mL adapter has a maximum radius of 7.3 cm. At 7,000 rpm a maximum g-force of 4,000 x g is reached.



## 3 Safety

### 3.1 Intended use

The Centrifuge 5424 / 5424 R is intended exclusively for indoor use and for separating aqueous solutions and suspensions of various densities in approved test tubes.

### 3.2 User profile

This device may only be operated by trained specialist staff. They must have carefully read the operating manual and be familiar with the function of the device.

### 3.3 Application limits

#### 3.3.1 Declaration concerning the ATEX directive (94/9/EC)



**DANGER! Risk of explosion.**

- ▶ Do not operate the device in areas where work is completed with explosive substances.
  - ▶ Do not use this device to process any explosive or highly reactive substances.
  - ▶ Do not use this device to process any substances which may generate an explosive atmosphere.
- 

Due to its design and the environmental conditions inside the device, the Centrifuge 5424 / 5424 R is not suitable for use in a potentially explosive atmosphere.

The device only must be used in a safe environment, such as the open environment of a ventilated laboratory or fume hood. The use of substances which could create a potentially explosive atmosphere is not permitted. The final decision on the risks associated with the use of these types of substances is the responsibility of the user.

#### 3.3.2 Maximum service life for accessories



**WARNING! Risk of injury from chemically or mechanically damaged accessories.**

Even minor scratches and cracks can lead to serious internal material damage.

- ▶ Protect all accessory parts from mechanical damage.
- ▶ Inspect the accessories for damage before each use. Replace any damaged accessories.
- ▶ Do not use rotors or buckets with signs of corrosion or mechanical damage (e.g., deformations).
- ▶ Do not use any accessories whose maximum service life has been exceeded.

**CAUTION! Risk of injury due to chemically damaged rotor lids or caps.**

Transparent rotor lids or caps made from PC, PP or PEI may lose their strength under the impact of organic solvents (e.g., phenol, chloroform).

- ▶ If rotor lids or caps have come into contact with organic solvents, they should be cleaned immediately.
- ▶ Regularly check the rotor lids and caps for damages and cracks.
- ▶ Immediately replace rotor lids or caps that have cracks or milky stains.

The rotors listed below, and the corresponding buckets and rotor lids, have a maximum service life of the number of years or cycles listed in the table (whichever comes first), starting with the initial start-up.

Accessories	Maximum service from the first commissioning onward
Transparent polypropylene (PP) rotor lids	3 years
Plastic adapters	1 year

For the other rotors and rotor lids of this centrifuge (see *Rotors on p. 10*) there is no limit on the service life as long as the following prerequisites are met: proper use, recommended maintenance and undamaged condition. To guarantee aerosol tightness, lids of aerosol-tight rotors must be replaced after 50 autoclaving cycles.

The following requirements must be met in order to use rotors, lids and accessories:

- Proper use,
- Recommended maintenance
- Undamaged condition

The date of manufacture is stamped on the rotors in the format *03/10* (= March 2010) or on the inside of the plastic rotor lids in the form of a clock 🕒. This is for information only and does not have any reference to the service life.

### 3.4 Information on product liability

In the following cases, the designated protection of the device may be compromised. Liability for any resulting property damage or personal injury is then transferred to the operator:

- The device is not used in accordance with the operating manual.
- The device is used outside of its intended use.
- The device is used with accessories or consumables which are not recommended by Eppendorf.
- The device is maintained or repaired by people not authorized by Eppendorf.
- The user makes unauthorized changes to the device.

## 3.5 Warnings for intended use

Read the operating manual and observe the following general safety instructions before using the Centrifuge 5424 / 5424 R.

### 3.5.1 Personal injury or damage to the equipment



**WARNING! Electric shock due to damage to device or mains cable.**

- ▶ Only switch on the device if the device and mains cable are undamaged.
- ▶ Only use devices that have been properly installed or repaired.
- ▶ In case of danger, disconnect the device from the mains supply by pulling the power plug from the device or the mains socket or, by using the isolating device intended for this purpose (e.g. emergency stop switch in the laboratory).



**WARNING! Lethal voltages inside the device.**

- ▶ Ensure that the housing is always closed and undamaged so that no parts inside the device can be contacted by accident.
- ▶ Do not remove the housing of the device.
- ▶ Do not allow any liquids to penetrate the inside of the housing.
- ▶ Do not allow the device to be opened by anyone except service personnel who have been specifically authorized by Eppendorf.



**WARNING! Risk from incorrect supply voltage**

- ▶ Only connect the device to voltage sources which correspond to the electrical requirements on the name plate.
- ▶ Only use sockets with a protective earth (PE) conductor and suitable power cable.



**WARNING! Damage to health due to infectious liquids and pathogenic germs.**

- ▶ When handling infectious liquids and pathogenic germs, observe the national regulations, the biological security level of your laboratory, the material safety data sheets, and the manufacturer's application notes.
- ▶ Use aerosol tight sealing systems for the centrifugation of these substances.
- ▶ When working with pathogenic germs belonging to a higher risk group, more than one aerosol-tight bioseal must be used.
- ▶ Wear personal protective equipment.
- ▶ For full instructions regarding the handling of germs or biological material of risk group II or higher, please refer to the "Laboratory Biosafety Manual" (Source: World Health Organization, current edition of the Laboratory Biosafety Manual).



**WARNING! Risk of injury when opening or closing the centrifuge lid.**

There is a risk of crushing your fingers when opening or closing the centrifuge lid.

- ▶ When opening or closing the centrifuge lid, do not reach between the lid and device or into the latching mechanism of the lid.
- ▶ Always open the centrifuge lid completely to prevent it from falling.

**CAUTION! Poor safety due to incorrect accessories and spare parts.**

The use of accessories and spare parts other than those recommended by Eppendorf may impair the safety, functioning and precision of the device. Eppendorf cannot be held liable or accept any liability for damage resulting from the use of incorrect or non-recommended accessories and spare parts, or from the improper use of such equipment.

- ▶ Only use accessories and original spare parts recommended by Eppendorf.

**NOTICE! Damage to device due to spilled liquids.**

1. Switch off the device.
2. Disconnect the device from the power supply.
3. Carefully clean the device and the accessories in accordance with the cleaning and disinfection instructions in the operating manual.
4. If a different cleaning and disinfecting method is to be used, contact Eppendorf AG to ensure that the intended method will not damage the device.

**NOTICE! Damage to electronic components due to condensation.**

Condensate can form in the device after it has been moved from a cool environment to a warmer environment.

- ▶ After installing the device, wait for at least 4 h. Only then connect the device to the mains power supply.

---

### 3.5.2 Incorrect handling of the centrifuge

**NOTICE! Damage from knocking against or moving the device during operation.**

If the rotor bangs against the rotor chamber wall, it will cause considerable damage to the device and rotor.

- ▶ Do not move or knock against the device during operation.

---

### 3.5.3 Incorrect handling of the rotors

**WARNING! Risk of injury from improperly attached rotors and rotor lids.**

- ▶ Only centrifuge with rotor and rotor lid firmly tightened.
- ▶ If unusual noises occur when the centrifuge starts, the rotor or the rotor lid may not be properly secured. Immediately press the **start/stop** key to stop centrifuging.





**CAUTION! Risk of injury due to asymmetric loading of a rotor.**

- ▶ Load rotors symmetrically with identical tubes.
- ▶ Only load adapters with suitable tubes.
- ▶ Always use the same type of tubes (weight, material/density and volume).
- ▶ Check symmetric loading by balancing the adapters and tubes used with scales.



**CAUTION! Risk of injury from overloaded rotor.**

The Centrifuge 5424 / 5424 R is designed for the centrifugation of material with a max. density of 1.2 g/mL at maximum speed and filling volume and/or load.

- ▶ Do not exceed the maximum load of the rotor.



**NOTICE! Damage to rotors from aggressive chemicals.**

Rotors are high-quality components which withstand extreme stresses. This stability can be impaired by aggressive chemicals.

- ▶ Avoid using aggressive chemicals, including strong and weak alkalis, strong acids, solutions with mercury, copper and other heavy metal ions, halogenated hydrocarbons, concentrated saline solutions and phenol.
- ▶ If the rotor is contaminated by aggressive chemicals, clean it immediately using a neutral cleaning agent. This applies to the rotor bores, in particular.
- ▶ Due to the manufacturing process, color variations may occur on rotors marked "coated". These color variations do not effect service life or resistance to chemicals.

### 3.5.4 Extreme strain on the centrifuging tubes



**CAUTION! Risk of injury from overloaded tubes.**

- ▶ Note the loading limits specified by the tube manufacturer.
- ▶ Only use tubes which are approved by the manufacturer for the required rcf.



**NOTICE! Risk from damaged tubes.**

Damaged tubes must not be used, as this could cause further damage to the device and the accessories and loss of the samples.

- ▶ Before use, visually check all of the tubes for damage.



**NOTICE! Risk from open tube lids.**

Open tube lids can brake off during centrifugation and damage the rotor and the centrifuge.

- ▶ Carefully seal all tube lids before centrifuging.  
Exception: Note the information on the centrifugation of spin columns in the rotor F-45-18-11-Kit (see *Loading the rotor on p. 27*).

**NOTICE! Hazard to plastic tubes from organic solvents.**

The density of plastic tubes is reduced when organic solvents (e.g., phenol, chloroform) are used, i.e. the tubes could become damaged.

- ▶ Observe the manufacturer's specifications for chemical resistance of the tubes.

**NOTICE! Sample tubes heat up.**

In uncooled centrifuges, the temperature in the rotor chamber, rotor and sample can increase to above 40 °C, based on the run time, g-force (rcf)/speed and ambient temperature.

- ▶ Note that this can reduce the centrifugation resistance of the sample tubes.
  - ▶ Please note the temperature resistance of the samples.
- 

### 3.5.5 Aerosol-tight centrifugation

---

**WARNING! Risk to health due to limited aerosol tightness with incorrect rotor/rotor lid combination.**

Aerosol-tight centrifugation is guaranteed only if the rotors and rotor lids intended for this purpose are used. The designation of aerosol-tight fixed-angle rotors always starts with **FA**. The aerosol-tight rotors and rotor lids of this centrifuge are additionally marked with a red ring on the rotor and a red rotor lid screw.





- ▶ For aerosol-tight centrifugation, always simultaneously use rotors and rotor lids which are marked as aerosol-tight in the centrifuge intended for the corresponding purpose. The details specifying in which centrifuge you may use the aerosol-tight rotors and rotor lids can be found on the rotor and, beginning from production date of October 2003, on the upper side of the rotor lid.
- ▶ Only use aerosol-tight rotor lids in combination with rotors which are marked on the rotor lid.

**WARNING! Damage to health as a result of limited aerosol tightness and incorrect usage.**

Autoclaving, mechanical stresses and contamination by chemicals or other aggressive solvents can impair the aerosol-tightness of the rotors and rotor lids.

- ▶ Check the integrity of the seals of the aerosol-tight rotor lids or caps before each use.
  - ▶ Only use aerosol-tight rotor lids or caps if the seals are undamaged and clean.
  - ▶ Lightly grease the threads of the rotor lid screw with pivot grease after every proper autoclaving (121 °C, 20 min.) (int. order no. Int. 5810 350.050, North America 022634330).
  - ▶ Replace aerosol-tight rotor lids after 50 autoclaving cycles.
  - ▶ **Never** store aerosol-tight rotors or buckets closed.
-

### 3.6 Safety instructions located on the device

Display	Meaning	Location
	Follow the instructions in the operating manual.	Right side of the device
 ALWAYS FASTEN THE ROTOR SECURELY WITH THE SUPPLIED ROTOR KEY	<b>CAUTION</b> Always tighten the rotor using the supplied rotor key.	Top of device, below the centrifuge lid
 ALWAYS CLOSE TUBES!  ALWAYS USE ROTOR LID WHEN USING SPIN COLUMNS!	<b>CAUTION</b> Close all tubes and use a rotor lid.	Top of device, below the centrifuge lid

**Safety**

Centrifuge 5424/5424 R  
English (EN)

## 4 Installation

### 4.1 Selecting the location



**NOTICE! If an error occurs, the objects in the immediate proximity of the device will be damaged.**

- ▶ In accordance with recommendations in EN 61010-2-020, leave a safety clearance of **30 cm** around the device during operation.
- ▶ Please remove all materials and objects from this area.



**NOTICE! Damage from overheating.**

- ▶ Do not install the device near heat sources (e.g. heating, drying cabinet).
- ▶ Do not expose the device to direct sunlight.
- ▶ Ensure unobstructed air circulation. Maintain a clearance of at least 30 cm around all ventilation grilles.

Select the location for the device according to the following criteria:

- Suitable power connection as per the name plate (230 V/120 V/100 V).
- Stable, horizontal and resonance-free lab bench.
- A well ventilated environment which is protected from direct sunlight to prevent the device from heating up more.

### 4.2 Preparing installation

#### Prerequisites

The weight of the Centrifuge 5424 / 5424 R is 13.4 kg or 21 kg . For unpacking and installing the Centrifuge 5424 / 5424 R, you require the assistance of another person.

Perform the following steps in the sequence described.

1. Open the packaging board.
2. Remove accessories.
3. Reach with your hands under the device and lift the centrifuge from the carton with another person.
4. Remove the front and back transport protection pads.
5. Place the device on a suitable lab bench.
6. Remove the plastic sleeve.

### 4.3 Installing the instrument

#### Prerequisites

The device is on a suitable lab bench.



**NOTICE! Damage to electronic components due to condensation.**

Condensate can form in the device after it has been moved from a cool environment to a warmer environment.

- ▶ After installing the device, wait for at least 4 h. Only then connect the device to the mains power supply.



**NOTICE! Centrifuge 5424 R: compressor damage after improper transport.**

- ▶ Only switch on the centrifuge 4 hours after installation.

Perform the following steps in the sequence described.

1. Let the device warm up to ambient temperature.
2. Check that the mains voltage and frequency match the requirements on the device type plate.
3. Connect the centrifuge to the mains and switch it on using the mains/power switch.
  - Display is active.
  - Lid opens automatically
4. **Only device version with rotor:** Turn the rotor counterclockwise using the supplied rotor key. **Only device version with rotor:** Remove rotor vertically upwards.
5. Remove the transport protection pad.
6. Fit the rotor vertically on the motor shaft.
7. Turn the rotor nut using the rotor key clockwise until the rotor nut is tightened.
8. Use the details included in the scope of delivery to check that the delivery is complete.
9. Check all parts for any transport damage. Contact your dealer if any damage is found.
10. **Only 5424 R:** Insert the condensation water tray at the left side of the device into the holder provided (see Fig. 2-2 on p. 7).



Retain the packaging material and the transport protection device for subsequent transport or storage. See also the instructions relating to transport (see p. 41).

## 5 Operation

### 5.1 Overview of operating controls

The Centrifuge 5424 / 5424 R is available in two versions: keypad or rotary knobs. This operating manual generally describes how to operate the keypad version. However, it also applies to the rotary knob version.

Before using the Centrifuge 5424 / 5424 R for the first time, familiarize yourself with the operating controls and the display.

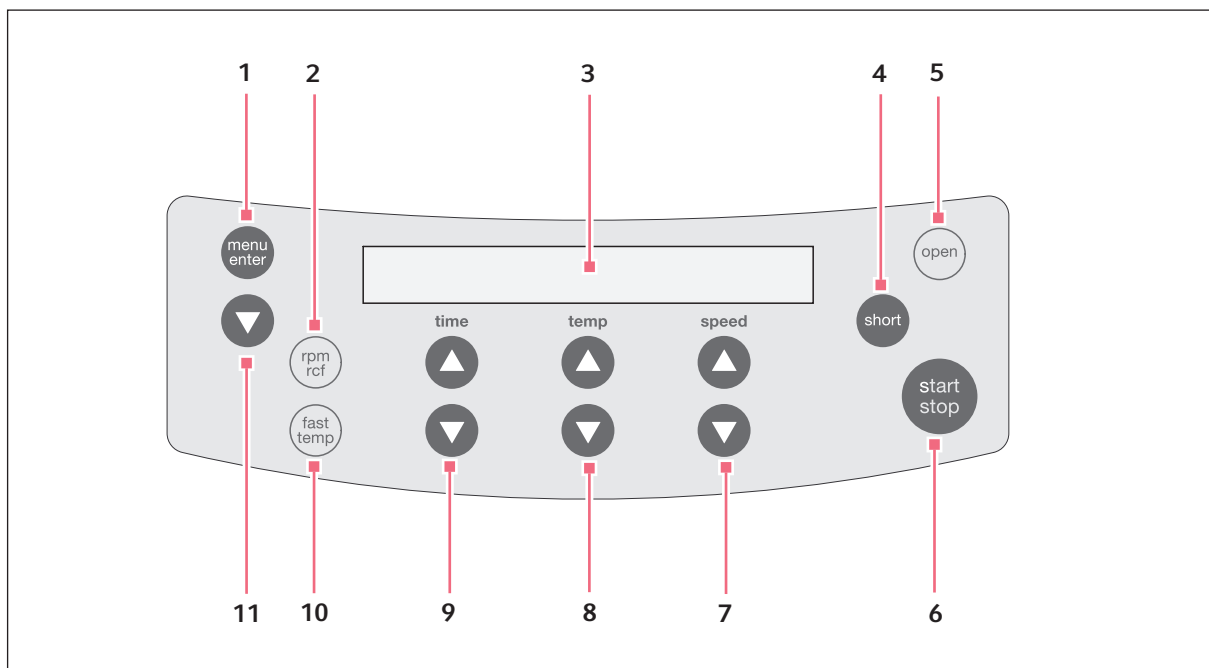

Fig. 5-1: Control panel of the Centrifuge 5424 / 5424 R

- |   |  |
|---|--|
| <p><b>1 Call and select the menu parameters</b><br/>(see <i>Device menu on p. 25</i>)</p> <p><b>2 Switch the displayed centrifugation speed (rpm/rcf)</b><br/>(see <i>Rcf display and calculation on p. 11</i>)</p> <p><b>3 Display</b></p> <p><b>4 Short spin centrifugation</b><br/>(see <i>Short-spin centrifugation on p. 32</i>)</p> <p><b>5 Release lid</b></p> <p><b>6 Start and stop centrifugation</b></p> | <p><b>7 Set centrifugation speed</b><br/>Dependent on device version designed as a key or dial.</p> <p><b>8 Adjust temperature (only 5424 R)</b></p> <p><b>9 Set centrifugation time</b><br/>Dependent on device version designed as a key or dial.</p> <p><b>10 Start the temperature control run fast temp (only 5424 R)</b></p> <p><b>11 Select the menu item</b><br/>(see <i>Menu navigation on p. 26</i>)</p> |
|---|--|

Please also read the precise description of the individual menu functions (see p. 25).

**Operation**

Centrifuge 5424/5424 R  
English (EN)

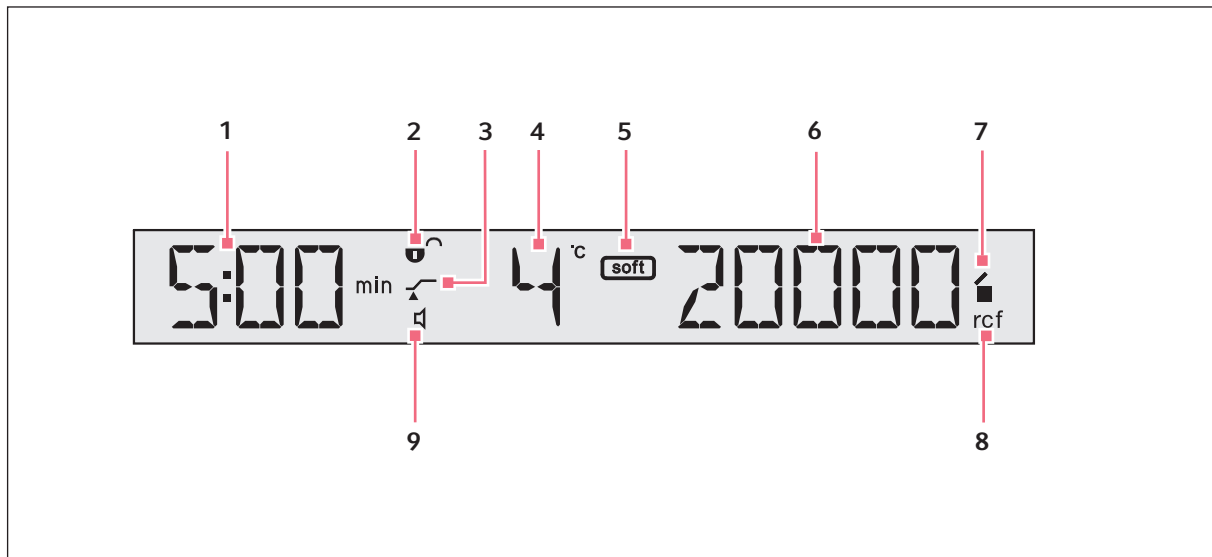

















Fig. 5-2: Display of the Centrifuge 5424 R, similar to the display of the Centrifuge 5424.

- |   |   |
|---|---|
| <p><b>1 Centrifugation time</b></p> <p><b>2 Status of the key lock (LOCK)</b><br/> : Centrifugation parameters cannot be modified unintentionally.<br/> : No key lock.</p> <p><b>3 Status of ATSET function</b><br/> : Start of run time when reaching 95% of the preset g-force (rcf) or speed (rpm).<br/> : Immediate start of run time.</p> <p><b>4 Temperature (only 5424 R)</b></p> <p><b>5 Soft ramp</b><br/> : Rotor accelerates and brakes slowly.<br/>           No symbol: fast acceleration and braking of rotor.</p> | <p><b>6 g-force (rcf) or speed (rpm)</b><br/> <i>(see Rcf display and calculation on p. 11)</i></p> <p><b>7 Status of centrifuge</b><br/> : Centrifuge lid unlocked.<br/> : Centrifuge lid locked.<br/>  (flashing): Centrifuging in progress.</p> <p><b>8 Status of centrifugation speed display</b><br/> <b>rcf</b>: g-force (relative centrifugal force)<br/> <b>rpm</b>: revolutions per minute</p> <p><b>9 Status of speaker</b><br/> : Switched on<br/> : Switched off</p> |
|---|---|



## 5.2 Device menu

Tab. 5-1: Menu structure of the Centrifuge 5424 / 5424 R.  
All menu levels contain the additional menu item **Back**.

Level 1 (M 1)	Level 2 (M 2)	Function	Display
<b>SOFT</b> Soft ramp: Reduce speed of acceleration and braking ramp. Not used for short spin centrifugation.	<b>On</b>	Rotor accelerates and brakes slowly.	
	<b>OFF</b>	Rotor accelerates and brakes rapidly.	
<b>LOCK</b> Key lock: Set the current centrifugation parameters permanently to prevent the time, temperature (only 5424 R) g-force (rcf) or speed (rpm) from being unintentionally modified.	<b>On</b>	Set the centrifugation parameters permanently. When you select the keys <b>time</b> , <b>temp</b> (only 5424 R) and <b>speed</b> , the display shows <b>SAFE</b> .	
	<b>OFF</b>		
<b>ATSET</b> Set start of centrifuging run time.	<b>On</b>	The set time is counted down only once 95% of the specified g-force (rcf) or speed (rpm) has been reached.	
	<b>OFF</b>	The set time is counted down immediately.	
<b>SHORT</b> Before the start of a short run (see <i>Short-spin centrifugation on p. 32</i> ) it is possible to switch between the maximum and currently set g-force (rcf) or speed (rpm). The SOFT function is not used for short spin centrifugation.	<b>MAX</b>	Short spin run at maximum g-force (rcf) or speed (rpm) of the rotor used.	
	<b>Set</b>	Short run at set g-force (rcf) or speed (rpm).	
<b>TEMP</b> (only 5424 R) Set the time limit for continuous cooling (see p. 29).	<b>8 h</b>	Preset value.	
	<b>oo</b>	Endless operation of continuous cooling. Icing possible! Note that this may reduce the service life of the compressor.	
<b>ALARM</b>	<b>On</b>	Switch on loudspeaker.	
	<b>OFF</b>	Switch off loudspeaker.	
<b>VOL</b>	<b>VOL1</b>	Adjust the speaker volume in 5 steps. The loudspeaker must be switched on for the adjustment to be audible.	
	<b>VOL5</b>		







## Operation

Centrifuge 5424/5424 R  
English (EN)

Level 1 (M 1)	Level 2 (M 2)	Function	Display
<b>SLEEP</b> Standby mode	<b>On</b>	If the centrifuge has not been used for 15 min and the standby mode has been switched on, it switches to standby mode. The <b>EP</b> logo then appears in the display. When a button or knob is used or the centrifuge lid is closed, the centrifuge is reactivated. It is then ready for operation.	
	<b>OFF</b>	Standby mode deactivated.	
<b>LID (only 5424)</b> Lid release, from software version 2.2.	<b>AUTO</b>	The centrifuge lid opens automatically after centrifugation.	
	<b>OFF</b>	The centrifuge lid must be manually opened with the <b>open</b> key after centrifugation.	

### 5.3 Menu navigation

To change settings in the device menu, proceed as follows:

1.		Open the menu.
2.		Select the desired menu item.
3.		Confirm your selection.
4.		Select the setting of the parameters in question.
5.		Confirm the changed setting. The <b>BACK</b> menu item belonging to the first menu level appears.
6.		Exit the menu.



To exit the second menu level without changing a parameter, select the **BACK** menu item and confirm with **menu/enter**.

### 5.4 Preparing for centrifugation

#### 5.4.1 Switching on the centrifuge

- Switch the centrifuge on using the mains/power switch.  
The centrifuge lid opens automatically after switching on using the mains/power switch.
- Open the closed centrifuge lid by pressing the **open** key.  
The parameter settings of the last run are displayed.

### 5.4.2 Inserting the rotor

1. Fit the rotor vertically on the motor shaft.
2. Insert the supplied rotor key into the rotor nut.
3. Turn rotor key **clockwise** until the rotor nut is firmly tightened.

### 5.4.3 Loading the rotor



#### CAUTION! Risk of injury due to asymmetric loading of a rotor.

- ▶ Load rotors symmetrically with identical tubes.
- ▶ Only load adapters with suitable tubes.
- ▶ Always use the same type of tubes (weight, material/density and volume).
- ▶ Check symmetric loading by balancing the adapters and tubes used with scales.



#### CAUTION! Risk from damaged or overloaded tubes.

- ▶ When loading the rotor, observe the safety precautions on dangers as a result of overloaded or damaged tubes (see *Warnings for intended use on p. 15*).



#### Rotor lid

- Fixed-angle rotors may only be operated with the appropriate rotor lid in each case. This is clearly shown by the identical rotor name labeling on the rotor and on the rotor lid.
- To carry out an aerosol-tight centrifugation, the aerosol-tight rotor (marked: **Red ring**) and the corresponding aerosol-tight rotor lid (marked: **Aerosol-tight** and **Red lid screw**) must be inserted.

To load the rotor, proceed as follows:

1. Check the maximum load (adapter, tube and contents) per rotor bore.  
The information about this can be found on every rotor and in this operating manual (see *Rotors on p. 10*).
2. Load rotors and adapters only with the tubes intended for them.
3. Insert tubes opposite each other in pairs into the rotor bores. For symmetric loading, tubes that face each other must be the same type and have the same filling quantity.

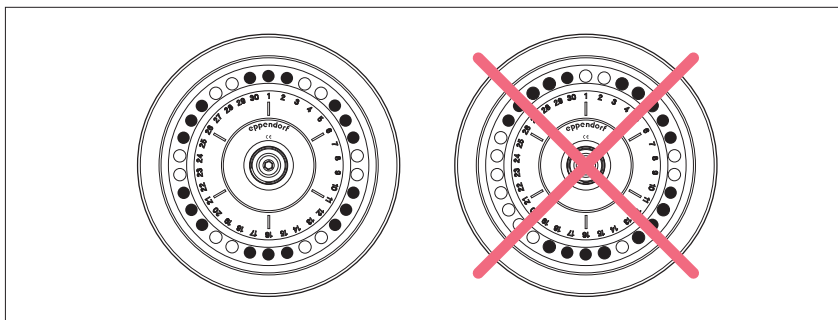

## Operation

Centrifuge 5424/5424 R  
English (EN)

To keep the weight differences between the filled tubes low, we recommend taring with a balance. This will reduce wear on the drive and reduce operating noise.

### 4. Attach and tighten rotor lid.



With the rotors FA-45-24-11 and FA-45-24-11-Special centrifugation is also possible without a rotor lid.

Please also note:

- The tube lids must be closed securely.
- The rotors are not aerosol-tight without rotor lid.
- The centrifugation is slightly louder.
- Spin columns must always be centrifuged with a rotor lid.



#### Spin columns

For centrifuging spin columns in the rotor F-45-18-11-Kit, you can leave the tube lids open. However, this is only permitted with the tubes specified by the kit manufacturers. For reliable centrifugation, you must lean the open tube lids against the edge of the rotor. Ensure that the lids do not protrude past the edge of the rotor in the process, then attach the matching rotor lid.

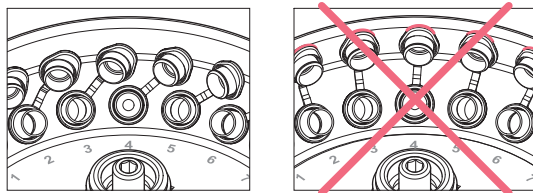

### 5.4.4 Closing the centrifuge lid



#### **WARNING! Risk of injury when opening or closing the centrifuge lid.**

There is a risk of crushing your fingers when opening or closing the centrifuge lid.

- ▶ When opening or closing the centrifuge lid, do not reach between the lid and device or into the latching mechanism of the lid.
- ▶ Always open the centrifuge lid completely to prevent it from falling.

1. Check correct attachment of rotor and rotor lid.
2. Push down the centrifuge lid until the lid latch engages and the lid is automatically closed.  
The centrifuge will close automatically.

The **open** key lights up blue. The display shows the ■ symbol.

## 5.5 Cooling (only 5424 R)

### 5.5.1 Temperature adjustment

- ▶ Set the temperature using the **temp** arrow keys from -10°C to +40°C.

The temperature can also be changed during centrifugation.

### 5.5.2 Temperature display

If the rotor is stopped:	Set temperature
During centrifugation:	Actual temperature

### 5.5.3 Temperature monitoring

After the set temperature has been reached the centrifuge responds as follows to temperature fluctuations during centrifugation:

Deviation from the target value	Action
$\Delta T > 3^{\circ}\text{C}$	Temperature display flashes.
$\Delta T > 5^{\circ}\text{C}$	Display <b>Error 18</b> . Centrifugation is stopped automatically.

### 5.5.4 FastTemp

This function can be used to start a temperature control run directly without samples with a rotor and temperature-specific speed in order to quickly adjust the rotor chamber up to the set target temperature.

#### Prerequisites

- The centrifuge is switched on.
- Rotor and rotor lid are correctly mounted.
- The centrifuge lid is closed.
- The temperature and g-force (rcf) or speed (rpm) are set for the subsequent centrifugation (see *Centrifuging on p. 30*).

#### 1. Press the **fast temp** key.

The display shows **FT** as well as the current temperature and g-force (rcf) or speed (rpm).  
The cooling time from room temperature () to 4 °C takes approx. 8 min.  
The temperature control cycle ends automatically when the target temperature has been reached. A periodic signal tone sounds.

#### 2. Press the **start/stop** key to end the temperature control run early.

After the temperature control run is complete the centrifuge keeps the rotor chamber, with the centrifuge lid closed, at the set temperature, if the temperature is below the ambient temperature. Irrespective of the target temperature, however, this continuous cooling does not go below 4°C to prevent the rotor chamber from freezing.

### 5.5.5 Continuous cooling

When the rotor is stopped the rotor chamber is kept at the target temperature when the following prerequisites are met:

- The centrifuge is switched on.
- The centrifuge lid is closed.
- The target temperature is below the ambient temperature.

**Operation**

Centrifuge 5424/5424 R  
English (EN)

During continuous cooling the following applies:

- The target temperature is displayed.
- Irrespective of the target temperature, continuous cooling does not go below 4°C to prevent the rotor chamber and the samples from freezing and increased condensation in the device.
- The temperature adjustment takes longer because the rotor is not rotating.

Open the centrifuge lid to end continuous cooling.

If the centrifuge is not used for more than 8 hours, the continuous cooling is switched off automatically. This protects against ice formation in the rotor chamber and the tubes, and against increased condensation in the device.

The device then switches to standby mode. The **EP** logo appears in the display.

With **fast temp** you can quickly reach the desired temperature again (see p. 29).

You can change continuous cooling to endless operation. To do so, in the device menu under **TEMP** enable the 'oo' (see p. 25) option. Note that this may reduce the service life of the compressor.

## 5.6 Centrifuging



### **CAUTION! Risk from incorrectly-loaded rotors and damaged/overloaded tubes!**

- ▶ Before commencing centrifugation, follow the safety instructions relating to risks from asymmetrically loaded and/or overloaded rotors and from overloaded, damaged and/or open tubes (see *Warnings for intended use* on p. 15).



### **WARNING! Risk of injury from improperly attached rotors and rotor lids.**

- ▶ Only centrifuge with rotor and rotor lid firmly tightened.
  - ▶ If unusual noises occur when the centrifuge starts, the rotor or the rotor lid may not be properly secured. Immediately press the key to stop centrifuging.
- 

Before using the Centrifuge 5424 / 5424 R for the first time, familiarize yourself with the operating controls and the display (see *Overview of operating controls* on p. 23).

Each of the centrifuging variants described here must be preceded by the preparation described above (see *Preparing for centrifugation* on p. 26).

**Only 5424 R:** Please also note the instructions on cooling (see p. 28).

### 5.6.1 Centrifugation with time setting

Perform the following steps in the sequence described.

1. Use **time** to set the run time.
2. **Only 5424 R:** Use **temp** to set the temperature.
3. Use **speed** to set the g-force (rcf) or speed (rpm).
4. Press **start/stop** to start centrifuging.

#### During centrifugation:

- In the display ■ flashes while the rotor is running.
- **Only 5424 R:** The current temperature will be displayed.
- The **fast temp** (only 5424 R), **open**, **short** as well as the device menu are blocked during centrifugation.
- During the run you can modify the total run time, the temperature (only 5424 R), the speed and the rpm/rcf display.  
The values flash in the display during the change. The new parameters are adopted immediately. When the time is changed during a run, the time which has already elapsed is taken into account. Please note that the shortest new total run time that can be set is the elapsed time plus 2 minutes.
- You can also terminate the centrifugation before the set run time has elapsed by pressing the **start/stop** key.

#### End of centrifugation

- The centrifuge automatically stops after the set time has elapsed. The elapsed centrifugation will be shown in a blinking display during the braking process. A signal tone sounds when the rotor is at a standstill.
- **Only 5424:** The centrifuge lid opens automatically. The display shows the symbol ■.
- **Only 5424 R:** The centrifuge lid remains closed to maintain the sample temperature. You can open it by pressing the **open** key.

5. Remove the material for centrifuging.

### 5.6.2 Centrifuging in continuous operation

Perform the following steps in the sequence described.

1. Use **time** to set the continuous run.  
The continuous run function can be set above 9:59 h or below 30 s. The timer shows **oo** to indicate continuous operation.

2. **Only 5424 R:** Use the **temp** arrow keys to adjust the temperature.
3. Use **speed** to set the g-force (rcf) or speed (rpm).
4. Press **start/stop** to start centrifuging.

In the display ■ flashes while the rotor is running.

Time is counted upwards, first in 30-second increments (5424) or second increments (5424 R) and then in minute increments from ten minutes.

5. Press **start/stop** to end centrifuging after the desired time period.

## Operation

Centrifuge 5424/5424 R  
English (EN)



- The centrifugation time will be shown in a blinking display during the braking process.
- A signal tone sounds when the rotor is at a standstill.
- **Only 5424:** The centrifuge lid opens automatically. The display shows the symbol .
- **Only 5424 R:** The centrifuge lid remains closed to maintain the sample temperature. You can open it by pressing the **open** key.

6. Remove the material for centrifuging.

### 5.6.3 Short-spin centrifugation

You can carry out a short run with the currently set or with the maximum g-force (rcf) or speed (rpm) of the rotor used. This is set in the device menu (see *Device menu on p. 25*) before executing the following steps in the sequence specified:

#### 5.6.3.1 Performing short spin centrifugation

1. A short run at current speed/g-force (rcf) or speed (rpm) can be set directly using the **speed** arrow keys.
2. **Only 5424 R:** Use the **temp** arrow keys to adjust the temperature.
3. Start short run: Hold down the **short** key.
  - In the display  flashes while the rotor is running.
  - The time is counted upwards in seconds.
  - During short run centrifuging all other keys are blocked.
4. End short run: Release the **short** key.
  - The centrifugation time will be shown in a blinking display during the braking process.
  - **Only 5424:** The centrifuge lid opens automatically. The display shows the symbol .
  - **Only 5424 R:** The centrifuge lid remains closed to maintain the sample temperature. You can open it by pressing the **open** key.
5. Remove the material for centrifuging.



During the braking process, you can restart the centrifugation up to two times by pressing the **short** key again.



The soft ramp does not work during short-spin centrifugation.

#### 5.6.4 Removing the rotor

1. Turn the rotor nut **counterclockwise** using the supplied rotor key.
2. Remove the rotor vertically in an upward motion.
3. **Only 5424 R:** Switch off the centrifuge after use and empty the condensation water tray (remove it from the left side of the device). Leave the centrifuge lid fully open and secure it against closing.



## 6 Maintenance

### 6.1 Prepare cleaning/disinfection

- ▶ Clean all accessible surfaces of the device and the accessories at least weekly and when contaminated.
- ▶ Clean the rotor regularly. This way the rotor is protected and the durability is prolonged.
- ▶ Furthermore, observe the notes on decontamination (see *Decontamination before shipment on p. 36*) when the device is sent to the authorized Technical Service for repairs.

The procedure described in the following chapter applies to the cleaning as well as to the disinfection or decontamination. The table below describes the steps required on top of this:

Cleaning	Disinfecting/decontamination
<ol style="list-style-type: none"> <li>1. Use a mild cleaning fluid to clean the accessible surfaces of the device and the accessories.</li> <li>2. Carry out the cleaning as described in the following chapter.</li> </ol>	<ol style="list-style-type: none"> <li>1. Choose the disinfection method which corresponds to the legal regulations and guidelines in place for your range of application. For example, use alcohol (ethanol, isopropanol) or alcohol-based disinfectants.</li> <li>2. Carry out the disinfection or decontamination as described in the following chapter.</li> <li>3. Then clean the device and the accessories.</li> </ol>



If you have any further questions regarding the cleaning and disinfection or decontamination or regarding the cleaning fluid to be used, contact the Eppendorf AG Application Support. The contact details are provided on the back of this manual.

### 6.2 Cleaning/disinfection



#### **DANGER! Electric shock as a result of penetration of liquid.**

- ▶ Switch off the device and disconnect the power plug before starting cleaning or disinfection work.
- ▶ Do not allow any liquids to penetrate the inside of the housing.
- ▶ Do not spray clean/spray disinfect the housing.
- ▶ Only plug the device back in if it is completely dry, both inside and outside.



#### **NOTICE! Damage from the use of aggressive chemicals.**

- ▶ Do not use any aggressive chemicals on the device or its accessories, such as strong and weak bases, strong acids, acetone, formaldehyde, halogenated hydrocarbons or phenol.
- ▶ If the device has been contaminated by aggressive chemicals, clean it immediately using a mild cleaning agent.

**NOTICE! Corrosion due to aggressive cleaning agents and disinfectants.**

- ▶ Do not use corrosive cleaning agents, aggressive solvents or abrasive polishes.
- ▶ Do not incubate the accessories in aggressive cleaning agents or disinfectants for longer periods.

**NOTICE! Damage from UV and other high-energy radiation.**

- ▶ Do not use UV, beta, gamma, or any other high-energy radiation for disinfecting.
- ▶ Avoid storage in areas with strong UV radiation

**Autoclaving**

All rotors, rotor lids and adapters can be autoclaved (121 °C, 20 min).

Replace the lids of the aerosol-tight rotors after a maximum of 50 autoclaving cycles.

**Aerosol tightness**

Check that the seals are intact before use.

Replace the rotor lids with screw cap when the sealing rings on the lid screw and in the lid groove become worn.

The sealing rings require regular care to protect the rotors.

Aerosol-tight rotors should never be stored with lids screwed on!

In order to prevent damage, lightly lubricate the lid thread of the aerosol-tight rotors with pivot grease (order no. Int.: 5810 350.050/North America: 022634330).

### 6.2.1 Cleaning and disinfecting the device

1. Open the lid. Switch off the device with the mains/power switch. Disconnect the power plug from the power supply.
2. Loosen the rotor nut by turning the rotor key **counterclockwise**.
3. Remove the rotor.
4. Clean and disinfect all accessible surfaces of the device, including the power cable, using a damp cloth and the recommended cleaning agents.
5. Thoroughly clean the rubber seals of the rotor chamber with water.
6. Rub the dry rubber seals with glycerine or talcum powder to prevent them from becoming brittle. Other components of the device, such as the lid latch, motor shaft and rotor cone, must not be lubricated.
7. Clean the motor shaft with a soft, dry and lint-free cloth. Do not lubricate the motor shaft.
8. Check the motor shaft for damage.
9. Inspect the device for corrosion and damage.
10. Leave the centrifuge lid open when the device is not being used.
11. Only connect the device to the power supply if it is fully dry inside and out.

## 6.2.2 Cleaning and disinfecting the rotor



Detailed instructions for cleaning and maintenance can be found in "Fixed-Angle Rotor - Basic Inspection" and "Swing-Bucket Rotor - Basic Inspection".

1. Inspect the rotor and accessories for damage and corrosion. Do not use any damaged rotors or accessories.
2. Clean and disinfect the rotors and accessories with the recommended cleaning agents.
3. Use a bottle brush to clean and disinfect the rotor bores.
4. Rinse the rotors and accessories thoroughly with distilled water. Rinse the rotor bores of fixed-angle rotors particularly thoroughly.



Do not immerse the rotor in liquid as liquid can get trapped inside the cavities.

5. Place rotors and accessories on a cloth to dry. Place fixed-angle rotors with the rotor bores facing downwards to allow the bores to also dry.
6. Clean the rotor cone with a soft, dry and lint-free cloth. Do not lubricate the rotor cone.
7. Inspect the rotor cone for damage.
8. Place the dry rotor onto the motor shaft.
9. Tighten the rotor nut firmly by turning it **clockwise** with the rotor key.
10. Leave the rotor lid open when the rotor is not being used.

## 6.3 Additional service instructions for Centrifuge 5424 R

- ▶ Empty and clean the condensation water tray regularly and especially after liquid spillage in the rotor chamber. Pull out the tray for condensation water from the left side of the centrifuge.
- ▶ Regularly free the rotor chamber ice formations via thawing, by leaving the centrifuge lid open or carrying out a short temperature control run at approx. 30 °C.
- ▶ Leave the centrifuge lid open when not in use for a long period.
  
- ▶ Wipe up condensate in the rotor chamber using a soft, absorbent cloth.
- ▶ Remove dust deposits from the ventilation slits of the centrifuge using a brush or swab at the latest every six months. First switch off the device and remove the power plug.

## 6.4 Glass breakage

When using glass tubes there is a risk of glass breakage in the rotor chamber. The resulting glass splinters are swirled around in the rotor chamber during centrifugation and have a sandblasting effect on the rotor and accessories. The smallest glass particles become lodged in the rubber parts (e.g., the motor guide, the rotor chamber seal, and the rubber mats of adapters).

**NOTICE! Glass breakage in the rotor chamber**

Glass tubes in the rotor chamber may break if the  $g$ -force is too high. Broken glass can damage the rotor, accessories and samples.

- ▶ Please note the manufacturer's information on the recommended centrifugation parameters (load and speed).

**Effects of glass breakage in the rotor chamber:**

- Fine black metal abrasion in the rotor chamber (in metal rotor chambers)
- The surfaces of the rotor chamber and accessories are scratched.
- The chemical resistance of the rotor chamber is reduced.
- Contamination of samples
- Wear on rubber parts

**How to proceed in case of glass breakage**

1. Remove all splinters and glass powder from the rotor chamber and accessories.
2. Thoroughly clean the rotor and rotor chamber. Thoroughly clean the bores of the fixed-angle rotors, in particular.
3. If required, replace the adapters to prevent any further damage.
4. Regularly check the rotor bores for deposits and damage.

## 6.5 Fuses

The fuse holder is located under the mains power socket (5424) (Fig. 2-1 on p. 7) or on the right next to the mains switch (5424 R) (Fig. 2-2 on p. 7).

1. Disconnect the mains plug.
2. Remove the fuse holder.

Both fuses are now accessible and can be replaced.

## 6.6 Decontamination before shipment

If you are shipping the device to the authorized Technical Service for repairs or to your authorized dealer for disposal please note the following:

**WARNING! Risk to health from contaminated device**

1. Follow the instructions in the decontamination certificate. It is available as a PDF file on our webpage ([www.eppendorf.com/decontamination](http://www.eppendorf.com/decontamination)).
2. Decontaminate all the parts you would like to dispatch.
3. Include the fully completed decontamination certificate in the package.

## 7 Troubleshooting

If you cannot remedy an error with the recommended measures, please contact your local Eppendorf partner. The contact address can be found online at: [www.eppendorf.com/worldwide](http://www.eppendorf.com/worldwide).

### 7.1 General errors

Symptom/message	Cause	Remedy
No display.	No mains power connection.	▶ Check the mains power connection.
No display.	Power failure.	▶ Check the mains fuse of the device (see <i>Fuses on p. 36</i> ). ▶ Check the mains fuse of the laboratory.
Lid of the device cannot be opened.	Rotor is still running.	▶ Wait for rotor to stop.
Lid of the device cannot be opened.	Power failure.	1. Check the mains fuse of the device (see <i>Fuses on p. 36</i> ). 2. Check the mains fuse of the laboratory. 3. Activate the emergency lid release (see p. 39).
Device cannot be started.	Lid of the device is not closed.	▶ Close the lid of the device.
Device shakes when it starts up.	Rotor is asymmetrically loaded.	1. Stop the device and load symmetrically. 2. Reboot device.
Centrifuge brakes during a short run centrifugation, although the <b>short</b> key is pressed.	The <b>short</b> key was released briefly more than twice (protective function for the drive).	▶ Press the <b>short</b> key continuously during a short run centrifugation.
Temperature display flashes. (only 5424 R)	Temperature deviation from the set value: $\pm 3$ °C.	▶ Check the settings. ▶ Check unhindered air circulation through the air slots. ▶ Thaw ice or switch off device and allow it to cool down.

## 7.2 Error messages

If one of the following error messages appears, proceed as follows:

1. Remove fault (see Remedies).
2. If necessary, repeat centrifugation.

Symptom/message	Cause	Remedy
<b>LID ERROR</b>	Centrifuge lid cannot be locked.	▶ Try again to close centrifuge lid.
<b>LID ERROR</b>	Centrifuge lid cannot be released.	<ol style="list-style-type: none"> <li>1. Switch the centrifuge off and back on.</li> <li>2. Press the <b>open</b> key.</li> </ol> <p>If the error occurs again:</p> <ol style="list-style-type: none"> <li>1. Switch off centrifuge.</li> <li>2. Activate the emergency lid release (see <i>Emergency release on p. 39</i>).</li> </ol>
<b>LID ERROR</b>	Centrifuge lid must not be released during a run.	▶ Wait for rotor to stop.
<b>LID LIFT</b> (only 5424 R)	Centrifuge lid has not been opened wide enough.	▶ Open the centrifuge lid wider by hand.
<b>INT</b>	Power failure during a run.	▶ Check the mains connection.
<b>NO RPM</b>	Error in the speed measuring system or drive overheated.	▶ Leave the device switched on until the error message disappears (10 s or 6 min).
<b>Err 6</b>	Drive fault.	<ol style="list-style-type: none"> <li>▶ Repeat the run.</li> <li>▶ If this error message appears again, switch centrifuge off and back on again after &gt; 20 s.</li> </ol>
<b>Err 6</b>	Drive overheated.	▶ Allow the drive to cool down for at least 15 min.
<b>Err 7</b>	Major deviation in the speed control.	<ol style="list-style-type: none"> <li>1. Wait for rotor to stop.</li> <li>2. Tighten the rotor.</li> </ol>
<b>Err 8</b>	Drive fault.	<ol style="list-style-type: none"> <li>1. Wait for rotor to stop.</li> <li>2. Repeat the run.</li> </ol>
<b>Err 9 to 17</b>	Electronics error.	▶ Switch the centrifuge off and back on again after > 20 s.
<b>Err 18</b> (only 5424 R)	Too high temperature deviation from set value in the rotor chamber.	<ol style="list-style-type: none"> <li>▶ Check the settings.</li> <li>▶ Check unhindered air circulation through the air slots.</li> <li>▶ Thaw ice or switch off device and allow it to cool down.</li> </ol>
<b>Err 19</b> (5424 R only)	Cooling circuit is overheated.	▶ Check unhindered air circulation through the air slots and allow device to cool down.

Symptom/message	Cause	Remedy
<b>Err 20</b> (only 5424 R)	Temperature sensor in rotor chamber is faulty.	▶ Switch centrifuge off and back on again after > 20 s.
<b>Err 21</b> (only 5424 R)	Temperature sensor on condenser is faulty.	▶ Switch centrifuge off and back on again after > 20 s.
<b>Err 24</b> (only 5424 R)	Cooling unit error, e.g. overheating	▶ Allow the centrifuge to cool down and repeat the run.

### 7.3 Emergency release

If the centrifuge lid cannot be opened, you can activate the emergency release manually.



**WARNING! Risk of injury from rotating rotor.**

If the emergency release of the lid is operated, the rotor may continue rotating for several minutes.

- ▶ Wait until the rotor stop before operating the emergency release.
- ▶ Check the monitoring glass in the centrifuge lid.



Use the rotor key delivered with the Centrifuge 5424 / 5424 R for the emergency release.

1. Pull the mains/power plug.
2. Remove the plastic cover for the emergency release on the right side of the device (see Fig. 1 and Fig. 2).
  - 5424:** Simply remove the plastic cover.
  - 5424 R:** Turn the plastic cover 90° **counterclockwise** using an appropriate tool (e.g., screwdriver) and remove it..
3. Insert the centrifuge rotor key in the rear hexagonal opening until a noticeable resistance is felt.
4. **Slightly press** and turn the rotor key counterclockwise.
  - This will release the centrifuge lid.
5. Open the centrifuge lid.
6. Remove the rotor key and fit or turn the plastic covers back on.
  - Only 5424 R:** Turn the plastic cover using an appropriate tool (e.g., screwdriver) by 90° in a **clockwise** direction.





## 8 Transport, storage and disposal

### 8.1 Transport



**CAUTION! Risk of injury due to lifting and carrying heavy loads**

The device is heavy. Lifting and carrying the device can lead to back injuries.

- ▶ Transport and lift the device with an adequate number of helpers only.
- ▶ Use a transport aid to transport the device.

- ▶ Remove the rotor from the centrifuge before transport.
- ▶ Use the original packaging and the transport securing devices for transport.

	Air temperature	Relative humidity	Atmospheric pressure
General transport	-25 °C – 60 °C	10 % – 75 %	30 kPa – 106 kPa
Air freight	-20 °C – 55 °C	10 % – 75 %	30 kPa – 106 kPa

### 8.2 Storage

	Air temperature	Relative humidity	Atmospheric pressure
In transport packaging	-25 °C – 55 °C	10 % – 75 %	70 kPa – 106 kPa
Without transport packaging	-5 °C – 45 °C	10 % – 75 %	70 kPa – 106 kPa

### 8.3 Disposal

In case the product is to be disposed of, the relevant legal regulations are to be observed.

**Information on the disposal of electrical and electronic devices in the European Community:**

Within the European Community, the disposal of electrical devices is regulated by national regulations based on EU Directive 2002/96/EC pertaining to waste electrical and electronic equipment (WEEE).

According to these regulations, any devices supplied after August 13, 2005, in the business-to-business sphere, to which this product is assigned, may no longer be disposed of in municipal or domestic waste. To document this, they have been marked with the following identification:



Because disposal regulations may differ from one country to another within the EU, please contact your supplier if necessary.

## 9 Technical data

### 9.1 Power supply

#### Centrifuge 5424

Mains power connection	230 V, 50 to 60 Hz 120 V, 50 to 60 Hz 100 V, 50 to 60 Hz
Current consumption:	1.9 A (230 V) 3.8 A (120 V) 4.0 A (100 V)
Power consumption:	max. 250 W
EMC: Interference emission (radio interference)	EN 61326 - category B
EMC: Noise immunity	EN 61326
Overvoltage category:	II
Fuses:	3.15 AT (230 V) 6.3 AT (120 V / 100 V)

#### Centrifuge 5424 R

Mains power connection	230 V, 50 to 60 Hz 120 V, 50 to 60 Hz 100 V, 50 to 60 Hz
Current consumption:	1.6 A (230 V) 3.2 A (120 V) 3.4 A (100 V)
Power consumption:	max. 350 W
EMC: Interference emission (radio interference)	EN 61326 - category B
EMC: Noise immunity	EN 61326
Overvoltage category:	II
Fuses:	3.15 AT (230 V) 6.3 AT (120 V / 100 V)

### 9.2 Ambient conditions

Environment:	For indoor use only.
Ambient temperature:	Centrifuge 5424: 2 to 40°C Centrifuge 5424 R: 10 to 40°C
Max. relative humidity:	10 to 75 %, non-condensing humidity
Atmospheric pressure:	Use up to an altitude of 2000 m above MSL.
Degree of contamination:	2

## 9.3 Weight/dimensions

### Centrifuge 5424

Dimensions:	Width: 236 mm (9.30 in.) Depth: 320 mm (12.60 in.) Height: 227 mm (8.94 in.)
Weight without rotor:	13.4 kg (29.5 lb)
Noise level:	< 51 dB(A) *

### Centrifuge 5424 R

Dimensions:	Width: 290 mm (11.42 in.) Depth: 480 mm (18.90 in.) Height: 260 mm (10.24 in.)
Weight without rotor:	21.0 kg (46.3 lb)
Noise level:	< 54 dB(A) *

\*) The noise level was measured according to DIN EN ISO 3745 frontally in a sound measuring room with accuracy class 1 at a distance of 1 m from the device and at lab bench height.

## 9.4 Application parameters

### 9.4.1 Centrifuge 5424

Tab. 9-1: Acceleration time and braking time according to DIN 58 970

Rotor	Without soft ramp		With soft ramp <i>SOFT</i>	
	Acceleration time	Deceleration time	Acceleration time	Deceleration time
FA-45-24-11	15 s	16 s	24 s	28 s

These values were calculated for 230 V at 23°C.

run time	30 s to 9:59 h, infinitely (∞), Adjustable to 10 min run time in 0.5 min increments, then increments of 1 min
Relative centrifugal force (RCF)	1 to 20,238 x g (230 V, 100 V) 1 to 21,130 x g (120 V) adjustable in 50 x g increments
RPM	100 rpm to 14,680 rpm (230 V, 100 V) 100 rpm to 15,000 rpm (120 V) adjustable in 50 rpm increments
Maximum load	24 micro test tubes of 2.0 mL each.
Maximum kinetic energy	4070 Nm
Compulsory test log book	No
Allowable density of the centrifuge material (at maximum g-force/speed and maximum load)	1.2 g/mL

### 9.4.2 Centrifuge 5424 R

Tab. 9-2: Acceleration time and braking time according to DIN 58 970

Rotor	Without soft ramp		With soft ramp <i>SOFT</i>	
	Acceleration time	Deceleration time	Acceleration time	Deceleration time
FA-45-24-11	15 s	16 s	26 s	8 s

These values were calculated for 230 V at 23°C.

run time	30 s to 9:59 h, infinitely (∞), Adjustable to 10 min run time in 0.5 min increments, then increments of 1 min
Temperature	-10°C to 40°C
Relative centrifugal force (RCF)	1 to 21,130 x g, adjustable in 50 x g increments
Rotational speed:	100 to 15,000 rpm, adjustable in 100 rpm increments
Maximum load	24 micro test tubes of 2.0 mL each.
Maximum kinetic energy	4070 Nm
Compulsory test log book	No
Allowable density of the centrifuge material (at maximum g-force/speed and maximum load)	1.2 g/mL



## 10 Ordering Information

### 10.1 Centrifuge 5424

Order no. (International)	Order no. (North America)	Description
5424 000.215 -	022620452 022620498	<b>Centrifuge 5424</b> with keypad, without rotor 230 V / 50 – 60 Hz 120 V / 50 – 60 Hz, with US-plug
5424 000.010 -	022620461 022620444	<b>Centrifuge 5424</b> with keypad, incl. rotor FA-45-24-11 230 V / 50 – 60 Hz 120 V / 50 – 60 Hz, with US-plug
5424 000.614 -	022620436 022620487	<b>Centrifuge 5424</b> with knobs, without rotor 230 V / 50 – 60 Hz 120 V / 50 – 60 Hz, with US-plug
5424 000.410 -	022620428 022620401	<b>Centrifuge 5424</b> with knobs, incl. rotor FA-45-24-11 230 V / 50 – 60 Hz 120 V / 50 – 60 Hz, with US-plug

### 10.2 Centrifuge 5424 R

Order no. (International)	Order no. (North America)	Description
5404 000.219 -	5404000219 5404000332	<b>Centrifuge 5424 R</b> with keypad, without rotor 230 V / 50 – 60 Hz 120 V / 50 – 60 Hz, with US-plug
5404 000.014 -	5404000014 5404000138	<b>Centrifuge 5424 R</b> with keypad, incl. rotor FA-45-24-11 230 V / 50 – 60 Hz 120 V / 50 – 60 Hz, with US-plug
5404 000.618 -	5404000618 5404000731	<b>Centrifuge 5424 R</b> with knobs, without rotor 230 V / 50 – 60 Hz 120 V / 50 – 60 Hz, with US-plug
5404 000.413 -	5404000413 5404000537	<b>Centrifuge 5424 R</b> with knobs, incl. rotor FA-45-24-11 230 V / 50 – 60 Hz 120 V / 50 – 60 Hz, with US-plug

**Ordering Information**Centrifuge 5424/5424 R  
English (EN)

## 10.3 Accessories

## 10.3.1 Rotors and rotor lids

Order no. (International)	Order no. (North America)	Description
5424 702.007	022653008	<b>Rotor FA-45-24-11</b> aerosol-tight, aluminum, 45° angle, 24 places, max. tube diameter 11 mm, incl. rotor lid (aluminum)
5424 703.003	022653024	<b>Replacement lid for rotor FA-45-24-11</b> aerosol-tight, aluminum
5424 700.004	022653041	<b>Rotor FA-45-24-11-Special</b> aerosol-tight, aluminum, PTFE-coated, 45° angle, 24 places, max. tube diameter 11 mm, incl. rotor lid (aluminum)
5424 701.000	022653067	<b>Replacement lid for rotor FA-45-24-11-Special</b> aerosol-tight, aluminum, PTFE-coated
5424 706.002	022653083	<b>Rotor F-45-18-11-Kit</b> aluminum, 45° angle, 18 places, max. tube diameter 11 mm, incl. rotor lid (polypropylene)
5424 707.009	022653105	<b>Spare lid for rotor F-45-18-11-Kit</b> Polypropylene
5424 704.000	022653121	<b>Rotor F-45-32-5-PCR</b> incl. rotor lid (aluminum)
5424 708.005	022653148	<b>Spare lid for rotor FA-45-32-5-PCR</b> aluminum

\*) Aerosol impermeability tested and certified by the Centre of Emergency Preparedness and Response, Health Protection Agency, Porton Down (UK).

## 10.3.2 Adapter

Order no. (International)	Order no. (North America)	Description
5425 715.005	022636260	<b>Adapter</b> used in FA-45-24-11, FA-45-24-11-Special and F-45-18-11-Kit for 1 PCR tube (0.2 mL, max. Ø 6 mm), set of 6
5425 717.008	022636243	for 1 sample tube (0.4 mL, max. Ø 6 mm), set of 6
5425 716.001	022636227	for 1 sample tube (0.5 mL, max. Ø 6 mm) or 1 Microtainer (0.6 mL, max. Ø 8 mm), set of 6



### 10.3.3 Other accessories

Order no. (International)	Order no. (North America)	Description
5416 301.001	022634305	<b>Rotor key</b> Standard
5404 850.085	5404850085	<b>Tray for condensation water</b>

### 10.4 Fuses

Order no. (International)	Order no. (North America)	Description
5424 852.122	950004267	<b>Fuse</b> 3,15 A T (230 V), set of 2
5424 852.130	950004241	6,3 A T (120 V/100 V), set of 2



# EG-Konformitätserklärung EC Conformity Declaration

Das bezeichnete Produkt entspricht den einschlägigen grundlegenden Anforderungen der aufgeführten EG-Richtlinien und Normen. Bei einer nicht mit uns abgestimmten Änderung des Produktes oder einer nicht bestimmungsgemäßen Anwendung verliert diese Erklärung ihre Gültigkeit.

The product named below fulfills the relevant fundamental requirements of the EC directives and standards listed. In the case of unauthorized modifications to the product or an unintended use this declaration becomes invalid.

Produktbezeichnung, Product name:

Centrifuge 5424 / 5424 R

einschließlich Zubehör / including accessories

Produkttyp, Product type:

Laborzentrifuge / Laboratory Centrifuge

Einschlägige EG-Richtlinien/Normen, Relevant EC directives/standards:

2006/95/EG, EN 61010-1, EN 61010-2-020

2011/65/EU

2004/108/EG, EN 55011/B, EN 61000-6-1, EN 61000-3-2, EN 61000-3-3, EN 61326-1

98/79/EG, EN 14971, EN 61010-2-101, EN 61326-2-6, EN 62366, EN 18113-3

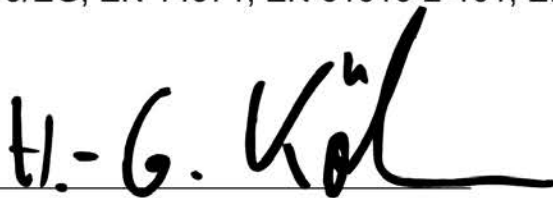

Vorstand, Board of Management:

14.08.2012

Hamburg, Date:



Projektmanagement, Project Management:

**eppendorf**



Eppendorf AG · Barkhausenweg 1 · 22339 Hamburg · Germany



# Certificate of Compliance

Certificate Number **20091210-E215059**  
Report Reference **E215059-A1-UL-1**  
Issue Date **2009 December 10**

Page 1



*Issued to:* Eppendorf A G

Barkhausenweg 1  
Hamburg, 22339  
Germany

*This is to certify that  
representative samples of*

Laboratory Use Electrical Equipment  
5424R

*Have been investigated by Underwriters Laboratories in accordance with  
the Standard(s) indicated on this Certificate.*

*Standard(s) for Safety:*

UL 61010-1, 2nd Edition, Electrical Equipment for Measurement, Control, and  
Laboratory Use; Part 1: General Requirements  
CAN/CSA-C22.2 No. 61010-1, 2nd Edition, Electrical Equipment for  
Measurement, Control, and Laboratory Use; Part 1: General Requirements

*Additional Information:*

See UL On-line Certification Directory at [WWW.UL.COM](http://WWW.UL.COM) for additional information.

Only those products bearing the UL Listing Mark for the US and Canada should be considered as being covered by UL's Listing and Follow-Up Service meeting the appropriate requirements for US and Canada.

The UL Listing Mark for the US and Canada generally includes: the UL in a circle symbol with "C" and "US" identifiers:  the word "LISTED"; a control number (may be alphanumeric) assigned by UL; and the product category name (product identifier) as indicated in the appropriate UL Directory.

**Look for the UL Listing Mark on the product**

**William Carney**  
Director, North American Certification Programs



Centre of Emergency Preparedness and Response  
Health Protection Agency  
Porton Down  
Salisbury  
Wiltshire SP4 0JG  
United Kingdom



## Certificate of Containment Testing

Containment Testing of Rotor FA 45-24-11  
(5424 700.101-00, 50 x autoclaved at 121°C  
for 20 minutes) in Eppendorf Centrifuge  
5424 / 5424R

Report No. 73-08 A

**Report prepared for:** Eppendorf AG, Hamburg, Germany  
**Issue Date:** 10<sup>th</sup> March 2008 (amended 24<sup>th</sup> Sept 2009)

### Test Summary

Rotor FA 45-24-11 (5424 700.101-00, 50 x autoclaved at 121°C for 20 minutes) was containment tested in the Eppendorf 5424 / 5424R centrifuge, using Annex AA of IEC 1010-2-20. The rotor was shown to contain a spill within the rotor.

**Report Written By**

*Anna May*

**Report Authorised By**

A handwritten signature in black ink, appearing to be "A. May", written over a horizontal dashed line.





Centre of Emergency Preparedness and Response  
Health Protection Agency  
Porton Down  
Salisbury  
Wiltshire SP4 0JG  
United Kingdom



## Certificate of Containment Testing

Rotor FA 45-24-11-Special  
(5424 700.101-00) in Eppendorf centrifuge  
5424 / 5424R

**Report No. 959-05 B**

**Report prepared for:** Eppendorf AG, Hamburg, Germany  
**Issue Date:** 29<sup>th</sup> June 2005 (amended 24<sup>th</sup> Sept 2009)

### Test Summary

The FA 45-24-11-Special rotor (5424 700.101-00) was containment tested in the Eppendorf centrifuge 5424 / 5424R, using Annex AA of IEC 1010-2-20. The rotor was shown to contain a large spill within the rotor.

**Report Checked By**

*Anna May*

**Report Written and Authorised By**

*[Signature]*





# Evaluate your manual

Give us your feedback.  
[www.eppendorf.com/manualfeedback](http://www.eppendorf.com/manualfeedback)